

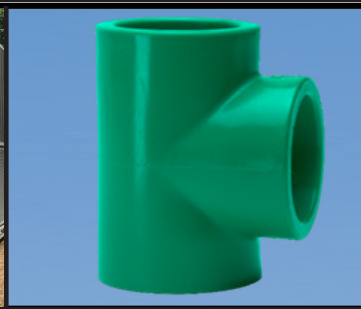

# PP-RCT Plumbing and HVAC Piping Systems

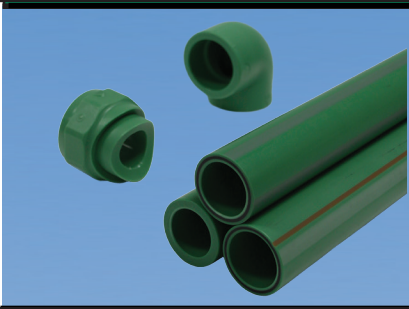

Pipe • Fittings • Valves

Another  
Corrosion  
Problem  
Solved.™



# Asahitec™ PP-RCT Plumbing and HVAC Piping Systems

## Efficient – Sustainable – Green Technology

Asahi/America, in partnership with Bänninger of Germany, presents Asahitec™ PP-RCT piping systems to the North American market.



PP-RCT is the latest advancement in polypropylene polymers and has a wide range of benefits for commercial plumbing and HVAC systems. It has a more complex crystalline structure than conventional PP materials, which provides greater pressure capabilities at higher temperatures.

## Features and Benefits

### Asahitec™ - The complete PP-RCT system

- Socket fusion from 20-125mm (1/2" – 5")
- Molded butt fusion from 160-500mm (6" – 20")
- NSF 14-pw certified for potable water applications
- Lead-free brass adapter fittings

### Molded butt fittings up to 500 mm (20")

- Provides full pressure rating over fabricated fittings
- Fast delivery
- Cost effective

### Wide range of manual and actuated valves

- Complemented by reliable Asahi valves
- Ball, butterfly, check, and more
- Full fleet of socket, butt, and electrofusion tools

available to rent or purchase

## Areas of Application

- Potable Water
- HVAC – Hot Water and Chilled Water
- Hydronics
- Buried and Above Ground Water Pipes
- Sports Stadiums and Arenas
- Commercial Buildings
- Residential Buildings
- Institutional Buildings
- Schools and Universities
- Government Buildings
- Hospitals, Hotels and Apartments



# Asahitec™ PP-RCT Plumbing and HVAC Piping Systems

## PP-RCT Piping Advantages

### Weight

- Steel pipe is approximately 3.5 times heavier than PP-RCT pipe (lbs/ft)
- Large and complex PP-RCT spools can be pre-fabricated to minimize field welds, yet still be manageable to install
- PP-RCT is both safer and more economical (less manpower required) to install

### Joining

- No welding rod, open flames, or solvent cements are required to join
- Creates a homogeneous joint—welds are as strong or stronger than the pipe itself
- Welding time is significantly reduced compared to metal options
- No noxious fumes are created by the welding process, making it ideal for enclosed spaces or buildings that will be applying for LEED certification

### Corrosion Resistance

- PP-RCT has an extremely high corrosion resistance—systems have a design life of 50 years, with no corrosion during this entire period
- Corroding metal pipes can introduce particles into the water system, adversely affecting all other system components such as pumps, valves, faucets and radiators

### Flow Capacity

- PP-RCT pipe has a higher Hazen-Williams flow coefficient than new steel pipe. As steel pipe ages, scaling and corrosion occur, further increasing this gap
- Compared to PP-R piping systems, PP-RCT may allow for a thinner-walled pipe in the same application, increasing flow capacity

### Insulation

- PP-RCT is a naturally insulating material, while metallic pipes are naturally conductive
- In certain applications, the insulation value provided by the pipe wall alone may prove sufficient to avoid condensation or retain the desired water temperature



# Asahitec™ PP-RCT Plumbing and HVAC Piping Systems

## PP-RCT Fibercore™ Technology

Fibercore™ PP-RCT pipes consist of three co-extruded layers that make one homogeneous pipe. The middle layer consists of mixed, short fiberglass strands and PP-RCT, which is isolated by solid layers of PP-RCT on the inside and outside of the pipe. The middle Fibercore™ layer reduces expansion and contraction by up to 75 percent, which reduces the installation cost by minimizing expansion loops, and the number of supports required in above ground systems. While the fittings do not have Fibercore™, fittings can be welded directly to all of Asahi's PP-RCT systems. Fibercore™ pipes are referred to as Climatec™ (thinner wall) and Watertec™ (thicker wall) depending on SDR.

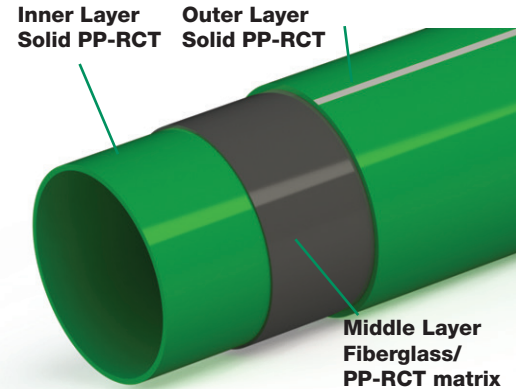

## Certifications

Certified to:

- ASTM F2389 – Standard PP Specification
- ASTM F2023 – Oxidative Resistance Test
- NSF/ANSI – 14 – Plastic Piping Systems
- NSF/ANSI – 61 – Drinking Water System Components
- Uniform Plumbing Code – (F2389)
- Uniform Mechanical Code – (F2389)
- CSA B137.11 – Standard Canadian PP Specification



In compliance with:

- ASME B31.3 (Process Piping)
- ASME B31.9 (Building Services Piping)



## Custom Fabrication

Asahi/America provides fully customizable assemblies, spools and fittings to support the most demanding customer needs. Our thermoplastic experts can assist in up-front design or post-design manufacturing.

Asahi/America offers:

- Full staff of engineers for design analysis
- Industry leading turnaround time
- On-site startup and product training
- Prefabrication and spool pieces



# Asahitec™ PP-RCT Plumbing and HVAC Piping Systems

## Asahitec™ Pipe Product Range

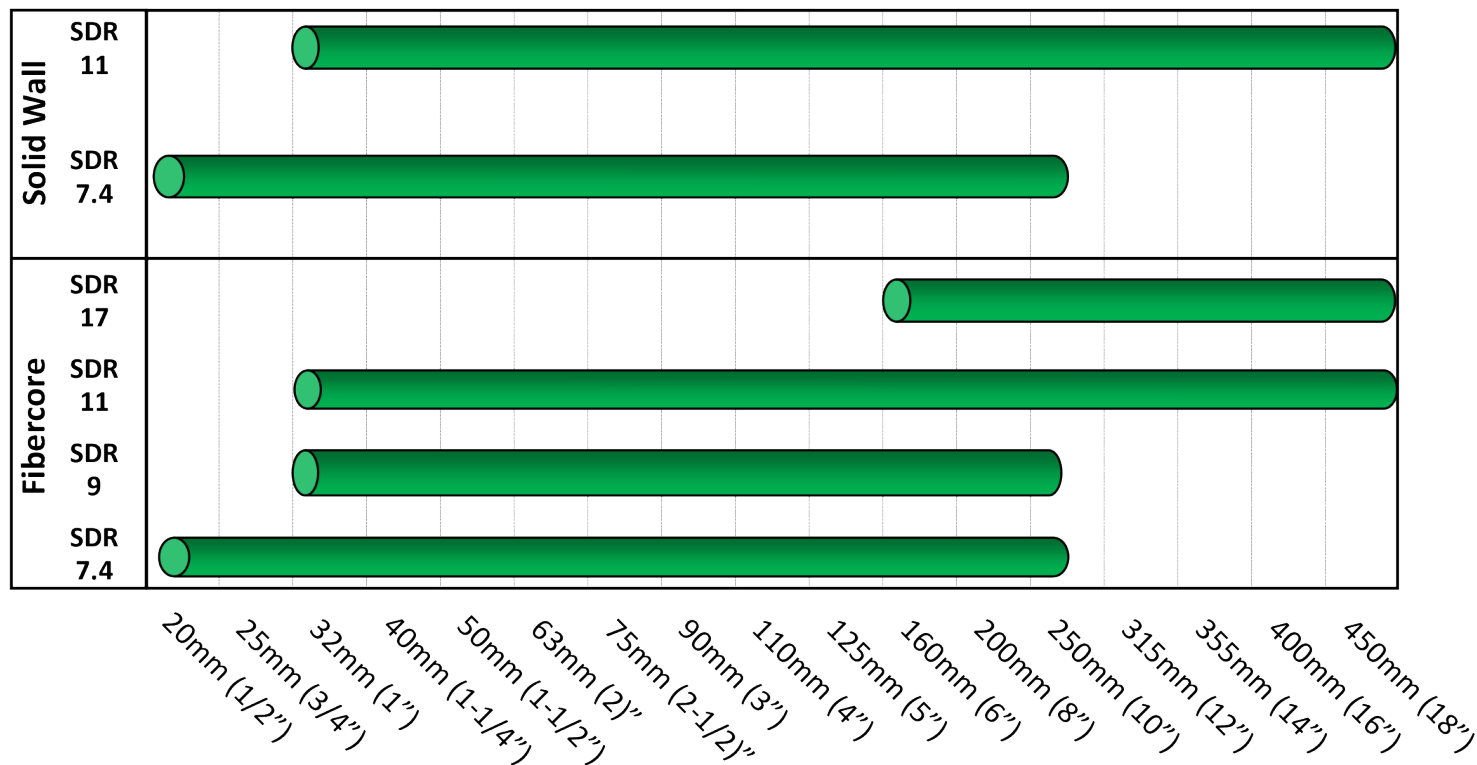

## Asahitec™ Short Sample Specification

### PP-RCT for Plumbing and HVAC Systems

Plumbing hot and cold water piping system shall be polypropylene pipe and fittings made of PP-RCT resin and certified by NSF International to 14-pw potable water. Material shall comply with NSF/ANSI 61 covering health effects requirements when tested at temperatures up to and including commercial hot water (180°F). Product shall be certified to the Universal Plumbing and Mechanical Codes UPC and UMC, ASTM F 2389 and 2023 or CSA B137.11. Pipe shall be extruded with Fibercore™ middle layer technology to limit thermal expansion. Pipe shall be identified by green color and grey or grey and red stripes. Fittings shall be molded only in green color; socket fusion style in sizes 1/2" – 5" and butt fusion style in sizes 6" – 20".

Pipe and fittings shall be Asahitec™, available from Asahi/America, Inc. of Lawrence, Massachusetts.

Full specifications and procurement information are available at [www.asahi-america.com](http://www.asahi-america.com).

Find us in

**MasterSpec**®

a product of The American Institute of Architects



# Asahitec™ PP-RCT Plumbing and HVAC Piping Systems

## Pressure/Temperature Range

Operating pressures are calculated from DIN Standard 8077, and systems are typically designed around an expected lifetime of 25 to 50 years. During this time, the system will experience no corrosion, no scaling, and no degradation of overall system performance.

Temp. (°F)	Pressure (psi)				
	Operating Years	SDR 7.4 20mm - 125mm (1/2" - 5") Solid or FC	SDR 9 20mm - 125mm (1/2" - 5") Solid or FC	SDR 11 32mm - 500mm (1" - 20") Solid or FC	SDR 17 160mm - 500mm (6" - 20") FC Only
68	10	436	347	276	174
	25	429	341	270	170
	50	423	335	267	168
	100	418	331	262	165
86	10	377	299	238	149
	25	370	293	233	146
	50	364	289	229	145
	100	360	286	226	142
104	10	323	257	204	128
	25	316	251	200	126
	50	312	248	197	123
	100	307	244	193	122
122	10	276	219	174	109
	25	270	213	170	107
	50	265	210	167	104
	100	261	207	164	103
140	10	232	184	146	93
	25	228	184	146	93
	50	223	177	141	88
158	10	196	155	123	77
	25	190	151	120	75
	50	187	148	117	74
176	10	165	131	104	65
	25	162	129	102	64
203	1	129	103	81	51
	5	123	97	77	48

# Asahitec™ PP-RCT Plumbing and HVAC Piping Systems

## System Design and Installation

### UV Resistance

Polypropylene pipe is not UV resistant and must be installed with sufficient protection if exposed to direct sunlight. The pipe may be painted with a latex paint or covered in a thin PVC jacketing.

Asahi/America does offer a pipe extruded with an additional UV-blocking layer: UV-TEC. This pipe can be installed in direct sun without any additional protection. Contact Asahi/America for more information.



UV-TEC

### Support Spacing

Thermoplastic piping systems must be supported more frequently than rigid metal piping to avoid excessive bending. Asahi/America recommends using pipe clips designed for plastic piping, which fully support the circumference and do not create point loads on the pipe wall.

Support spacing charts are available from Asahi/America upon request, or can be found in our Engineering Design Guide online.

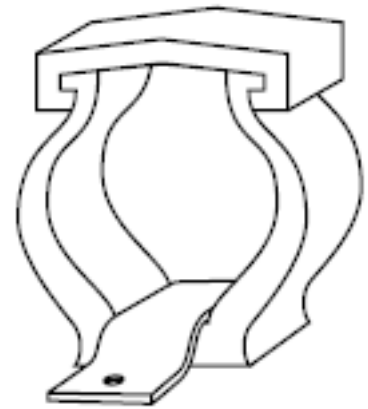

Recommended Pipe Clamp

### Thermal Expansion

Change in length due to thermal expansion must be considered if the temperatures during installation and operation are different. Plastic pipe will expand as temperatures increase. To calculate the change in length, the following formula may be used:

$$\Delta L = \alpha \times \Delta T \times L$$

Where:

$\Delta L$  = Change in length due to temperature change [mm]

$\alpha$  = Linear Expansion Coefficient [mm/m/K]

$\alpha$  = 0.15 mm/m/K for solid wall PP-RCT

$\alpha$  = 0.035 mm/m/K for Fibercore™ PP-RCT

$\Delta T$  = Change in temperature [K or C]

L = Original pipe length [m]

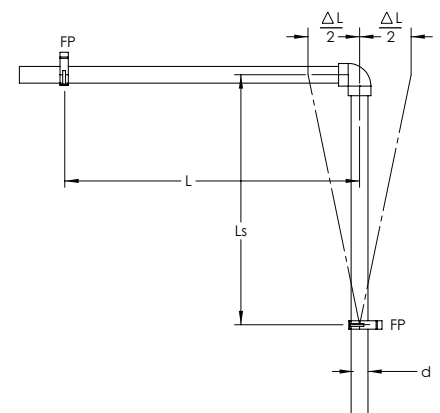

Try the expansion calculator on our website.

<https://www.asahi-america.com/resource-center/online-tools/expansion-calculator>



# Asahitec™ PP-RCT Plumbing and HVAC Piping Systems

## Welding Methods

There are three primary joining methods used for Asahitec™ piping systems: butt, socket and electrofusion. Often a system will employ more than one of these options in order to facilitate the installation the best way possible. Each method yields an integrous – full pressure rated – fusion joint as strong as the pipe itself.

Asahitec™ fittings for socket fusion are available from 1/2" (20mm) through 5" (125mm), and in 6" (160mm) and larger for butt fusion. Electrofusion couplings are offered for the complete size range. All pipe sizes may be butt welded pipe-to-pipe if desired.



### Butt Fusion

Butt fusion is where the ends of the pipes and/or fittings are butted together. This method always produces a minimum bead on both the inside and outside of the joint. In this method, couplings are not required to make pipe-to-pipe connections. Butt fusion is available in two formats: contact and non-contact (also known as infra-red or IR). The difference is that, during contact the material touches the heater plate and in non-contact the material does not touch the heat source. Most industrial fluid handling applications use contact fusion. Butt fusion is available from 1/2" up to 60" size diameters.

The illustration to the right shows the contact butt fusion process.

The basic steps are as follows:

- **Initial Melt:** After planing the pipes, they are applied to the heater plate under an initial pressure until a melt is seen all the way around.
- **Heat Soak:** Once the initial melt is achieved, the pressure is lowered close to zero and the heat soak time is counted.
- **Joining:** After the heat soak time, the pipes are separated from the heater plate, the heater plate is removed and then (while the two surfaces are still molten), the pipes are joined together quickly and the welding pressure is applied.
- **Cooling:** The joint is left alone (under pressure) during the cooling time.

The process is complete and the joint can be immediately moved to prepare for the next joint.

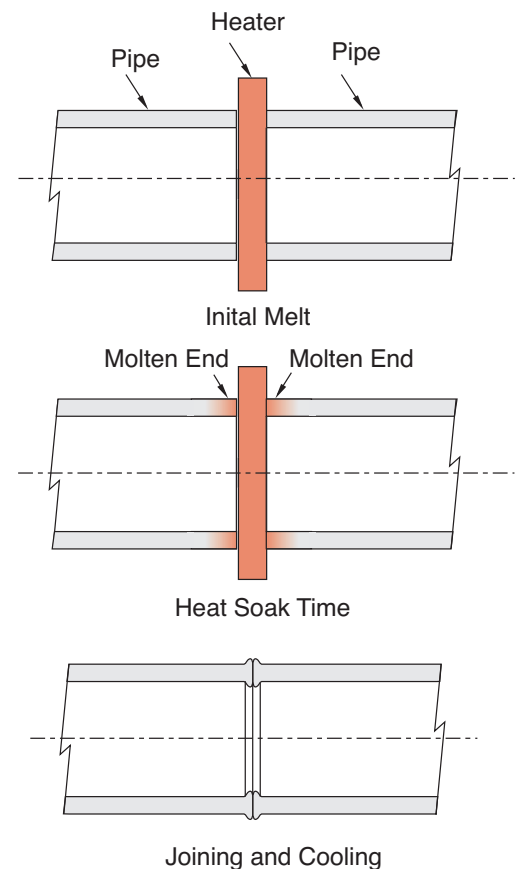



## Welding Methods



### Socket Fusion

Socket fusion is where the inside socket of the fitting and the outside surface of the pipe are melted and the pipe is then inserted into the socket of the fitting. This method is available in size range from 1/2" up to 5". Socket fusion tools are available in a hand-held version and a bench version. Hand-held socket fusion is usually used for smaller sizes like 1/2" – 1-1/2" while the bench tool can be used for all sizes.

The illustration to the right shows socket fusion steps:

- **Melting the Pipe and Fitting:** After prepping the end of the pipe, insert the pipe and the fitting onto the heater bushings simultaneously and hold for the heating time.
- **Making the Joint:** After the heating time, pull the pipe and fitting off the heater bushings and immediately insert the pipe into the socket of the fitting up to the socket depth.
- **Cooling:** After ensuring the pipe has been inserted properly, allow the new fitted joint to cool for the specified time before moving the joint.

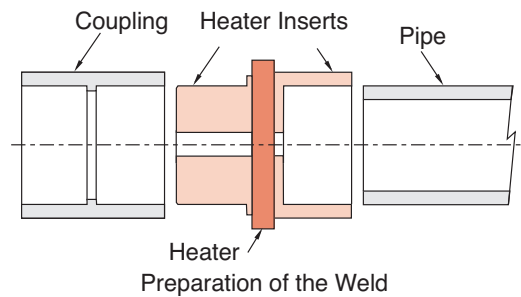

Preparation of the Weld

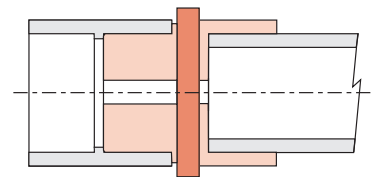

Alignment and Preheat

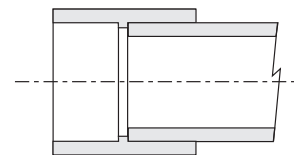

Joining and Cooling



### Electrofusion

Electrofusion utilizes couplings only. The electrofusion coupling has a metal coil embedded just under the surface of the inside wall of the fitting. There are two leads that come out of the fitting for connecting the wires to the fitting for fusion. Electrofusion is used more for convenience rather than as the primary joining method for an entire project. It is especially useful in making position joints over head in a rack where it is more difficult to use butt or socket fusion.

The illustration to the right shows the electrofusion process:

- **Welding the Joint:** After peeling the two pipes, insert both into the socket of the coupling up to the stop. Two leads are connected to the coupling from the heating unit. The joint is then fused.
- **Cooling:** After fusion, the coupling should be allowed to cool for the prescribed curing time. After curing, the joint can be moved.

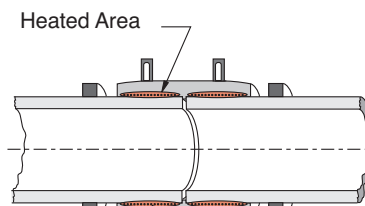

The molten area increases and heat is transferred to the surface of the pipe, which in turn begins to melt.

Initial Heating

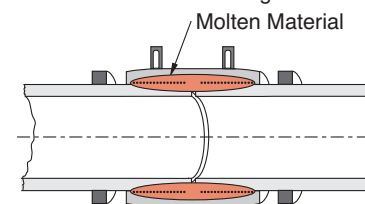

Weld Forms

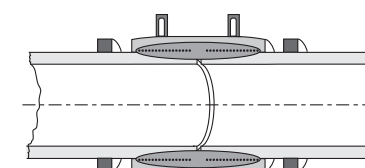

Completed Weld



# Asahitec™ PP-RCT Plumbing and HVAC Piping Systems

## Welding Equipment Available for Purchase or Rent



### Socket Fusion



**Hand Held Socket 2**  
Socket fusion tool welds 20mm - 63mm (1/2" - 2") pipe.



**Bench Socket**  
Socket fusion welding of components from 20mm - 125mm (1/2" - 4-1/2").



**Spider Socket**  
Socket fusion welding of components from 63mm—125mm (2" - 5"), especially overhead tie-ins



### Butt Fusion



**Maxiplast®**  
Butt fusion tool available for 110mm - 160mm (4" - 6") straight or mitered welds 50mm - 160mm (1-1/2" - 6").



**Shop 12**  
Bench-style butt fusion tool for 50mm - 315mm (1-1/2" - 12") PP and PVDF welding.

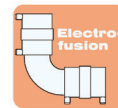

### Electrofusion



**Polymatic**  
Electrofusion tool for welding PP and HDPE couplings for Asahitec™.



### Butt Fusion Field Hydraulic Equipment



Tool	Power	Plug (Provided)	Size Range
Field 6	230V /1ph 20A	NEMA L6-20P	50mm - 160mm (1-1/2" - 6")
Field 10	110V /1ph 20A	-	75mm - 250mm (2-1/2" - 10")
Field 12	230V /1ph 20A	NEMA L6-20P	90mm - 315mm (3" - 12" IPS)
Field 12/IPS	110V /1ph 20A	-	90mm - 315mm (3" - 12" IPS)
Field 14	230V /1ph 20A	NEMA L6-20P	90mm - 355mm (3" - 14")
Field 20	230V /3ph 30A	NEMA L15-30P	200mm - 500mm (8" - 20")
Field 24	230V /3ph 30A	NEMA L15-30P	315mm - 630mm (12" - 24")

# Asahitec™ PP-RCT Plumbing and HVAC Piping Systems

## Performance Valve Offerings

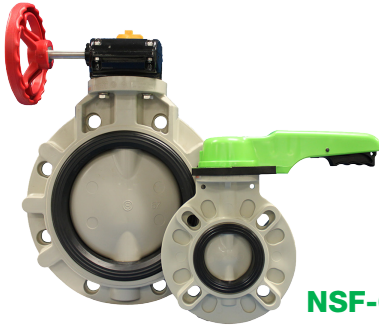

NSF-61 Certified

### Type-57AT Butterfly Valve

**Size Range:** Lever: 1-1/2" - 8", Gear: 1-1/2" - 14"

**Models:** Wafer style, lug style

**Materials:** PP body, PP disc, EPDM seat/seals, 316SS stem

#### Features:

- Full seat design eliminates need for flange gaskets
- No metal-to-media contact, only disc and seat are wetted components
- Rated for 100psi at 180°F through 12"
- ISO 5211 bolt pattern on top flange for easy actuation
- Seat over-torquing protection
- Clear position indication on both lever and gear models
- Additional models available in PP up to 24"
- ANSI Class IV bubble-tight shutoff
- Backed by 3-year warranty



### Type-21AT Ball Valve

**Size Range:** 1/2" - 4"

**Materials:** PP body, PTFE seats, EPDM seals

**End Connections:** PP-RCT socket weld standard, threaded and flanged also available

#### Features:

- True union designed allows for easy removal from pipe
- No metal-to-media contact
- Applications to 150psi and temps to 180°F
- Double O-ring seals on stem for added protection
- Built-in spanner wrench on handle for valve assembly/disassembly
- PTFE seats with EPDM backing cushions ensure bubble-tight shutoff while compensating for wear
- Backed by 3-year warranty

## Actuators and Options



### Electric Actuators

**Size Range:** Up to 24" Valves

**Enclosures:** Weatherproof NEMA 4X

**Voltage:** 120VAC standard. 220VAC, 12/24VDC, and 12/24VDC options

**Manual Override:** Standard

#### Options:

- Auxiliary contacts for position feedback to PLC
- Digital/analog positioners and feedback cards for modulating service
- Battery back-up for failsafe service
- Local/remote stations



### Pneumatic Actuators

**Size Range:** Up to 24" Valves

**Models:** Single Acting (Air-Spring Failsafe), Double Acting (Air-Air)

**Enclosures:** Glass-filled polyamide, cataphoresis/Rilsan coated cast aluminum

#### Options:

- NEMA 4X solenoids
- Limit switches for position feedback to PLC
- 4-20mA positioners for modulating service
- Declutchable manual override



### Tandem Assemblies

Offered as complete drop-in actuated valve and tandem assembly

**Size Range:** Up to 12" valves  
**Models:** Electric, single-acting pneumatic, double-acting pneumatic

**Materials:** Polypropylene valves, PP-RCT tee and flanges, stainless steel linkage

**Flow Layouts:** "Branch" or "on-the-run"



# Another Corrosion Problem Solved.™



Tel: 800-343-3618; 781-321-5409

Direct Sales: East (800) 232-7244  
Central (800) 442-7244  
West (800) 282-7244

Fax: 800-787-6861

[www.asahi-america.com](http://www.asahi-america.com)  
[asahi@asahi-america.com](mailto:asahi@asahi-america.com)