

Serial No.	H-V013-E-14
------------	-------------

Swing Check Valve

User's Manual





Contents



- (1) Be sure to read the following warranty clauses of our product1
- (2) General operating instructions2
- (3) General instructions for transportation, unpacking and storage3
- (4) Name of parts4
- (5) Working pressure vs. temperature6
- (6) Seal performance7
- (7) Installation procedure7
- (8) Disassembling method for replacing parts9
- (9) Inspection items11
- (10) Troubleshooting11
- (11) Handling of residual and waste materials11

This user's guide contains information important to the proper installation, maintenance and safe use of an ASAHI AV Product. Please store this manual in an easily accessible location.

<Warning & Caution Signs>

 Warning	This symbol reminds the user to take caution due to the potential for serious injury or death.
 Caution	This symbol reminds the user to take caution due to the potential for damage to the valve if used in such a manner.

<Prohibited & Mandatory Action Signs>

	Prohibited: When operating the valve, this symbol indicates an action that should not be taken.
	Mandatory action: When operating the valve, this symbol indicates mandatory actions that must be adhered to.

(1) Be sure to read the following warranty clauses of our product

- Always observe the specifications of and the precautions and instructions on using our product.
- We always strive to improve product quality and reliability, but cannot guarantee perfection. Therefore, should you intend to use this product with any equipment or machinery that may pose the risk of serious or even fatal injury, or property damage, ensure an appropriate safety design or take other measures with sufficient consideration given to possible problems. We shall assume no responsibility for any inconvenience stemming from any action on your part without our written consent in the form of specifications or other documented approval.
- The related technical documents, operation manuals, and other documentation prescribe precautions on selecting, constructing, installing, operating, maintaining, and servicing our products. For details, consult with our nearest distributor or agent.
- Our product warranty extends for one and a half years after the product is shipped from our factory or one year after the product is installed, whichever comes first. Any product abnormality that occurs during the warranty period or which is reported to us will be investigated immediately to identify its cause. Should our product be deemed defective, we shall assume the responsibility to repair or replace it free of charge.
- Any repair or replacement needed after the warranty period ends shall be charged to the customer.
- The warranty does not cover the following cases:
 - (1) Using our product under any condition not covered by our defined scope of warranty.
 - (2) Failure to observe our defined precautions or instructions regarding the construction, installation, handling, maintenance, or servicing of our product.
 - (3) Any inconvenience caused by any product other than ours.
 - (4) Remodeling or otherwise modifying our product by anyone other than us.
 - (5) Using any part of our product for anything other than the intended use of the product.
 - (6) Any abnormality that occurs due to a natural disaster, accident, or other incident not stemming from something inside our product.

(2) General operating instruction



Warning

- Using a positive-pressure gas with our plastic piping may pose a dangerous condition due to the repellent force particular to compressible fluids even when the gas is under similar pressures used for liquids. Therefore, be sure to take the necessary safety precautions such as covering the piping with protective material. For inquiries, please contact us. For conducting a leak test on newly installed piping, be sure to check for leaks under water pressure. If absolutely necessary to use a gas in testing, please consult your nearest service station beforehand.



Caution

- Do not step on or apply excessive weight on valve. (It can be damaged.)
- Do not use the valve in conditions where the fluid may have crystallized. (The valve will not operate properly.)
- Keep the valve away from excessive heat or fire. (It can be damaged, or destroyed.)
- Always operate the valve within the pressure vs. temperature range. (The valve can be damaged or deformed by operating beyond the allowable range.)
- Allow sufficient space for maintenance and inspection.
- Select a valve material that is compatible with the media. For chemical resistance information, refer to "CHEMICAL RESISTANCE ON ASAHI AV VALVE". (Some chemicals may damage incompatible valve materials.)
- Keep the valve out of direct sunlight, water and dust. Use cover to shield the valve. (The valve will not operate properly.)
- Perform periodic maintenance. (Leakage may develop due to temperature changes or periods of prolonged storage, rest, or operation.)
- Use the valve at a pressure exceeding the minimum operating differential pressure. (Check the effective head.)
- A temperature change and creep during storage or use may loosen the bonnet. Inspect the valve and retighten the bonnet and body.

(3) General instructions for transportation, unpacking and storage



Warning

- When suspending and supporting a valve, take care and do not stand under a suspended valve.



Caution

- This valve is not designed to handle impacts of any kind. Avoid throwing or dropping the valve.

- Avoid scratching the valve with any sharp object.

- Do not over-stack cardboard shipping boxes. Excessively stacked packages may collapse.

- Avoid contact with any coal tar creosote, insecticides, vermicides or paint.

(These chemicals may cause damage to the valve.)

- When transporting a valve, do not carry it by the handle.



- Store products in their corrugated cardboard boxes. Avoid exposing products to direct sunlight, and store them indoors (at room temperature). Also avoid storing products in areas with excessive temperatures. (Corrugated cardboard packages become weaker as they become wet with water or other liquid. Take care in storage and handling.)

- After unpacking the products, check that they are defect-free and meet the specifications.

(4) Name of parts

Nominal size 15, 20mm (1/2", 3/4")

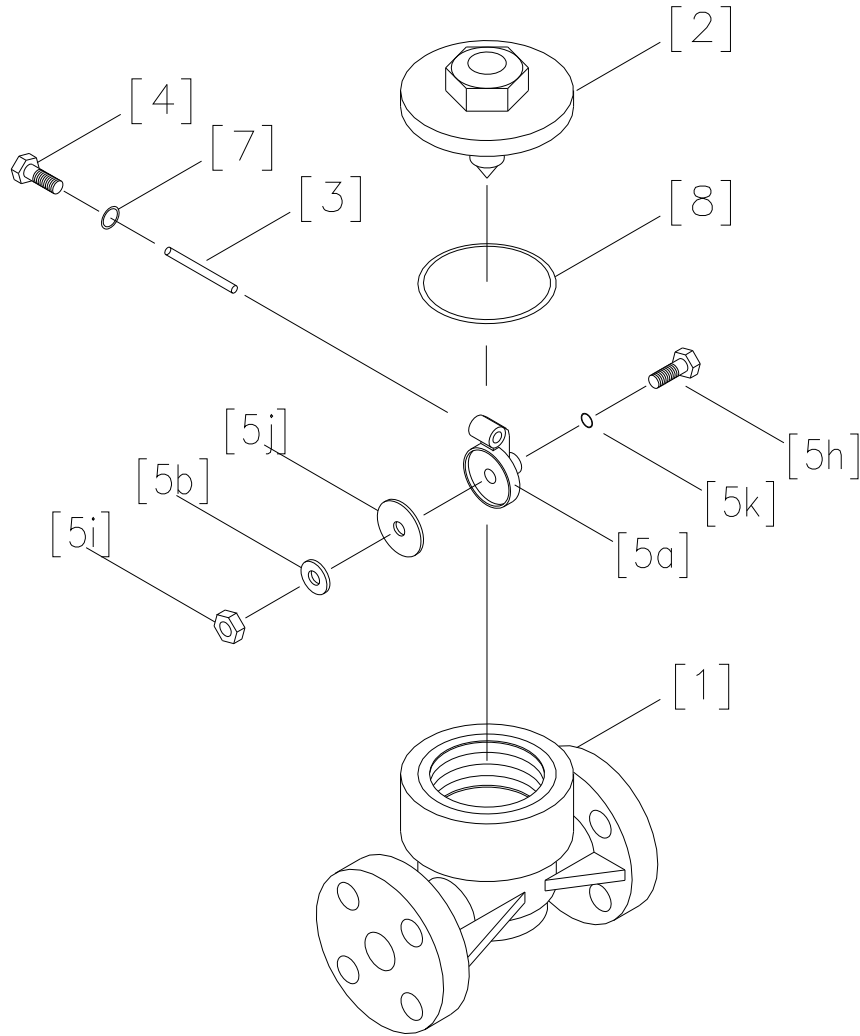

No.	DESCRIPTION	No.	DESCRIPTION	No.	DESCRIPTION	
[1]	Body	[5]	[5a]	[5]	[5j]	Seat
[2]	Bonnet		[5b]	[5]	[5k]	O-ring (A)
[3]	Shaft		[5h]	[7]		Gasket (B)
[4]	Plug		[5i]	[8]		O-ring (B)

*The assembly of Disc ([5a]-[5k]) is not disassembly.

Nominal size 25-200mm (1"-8")

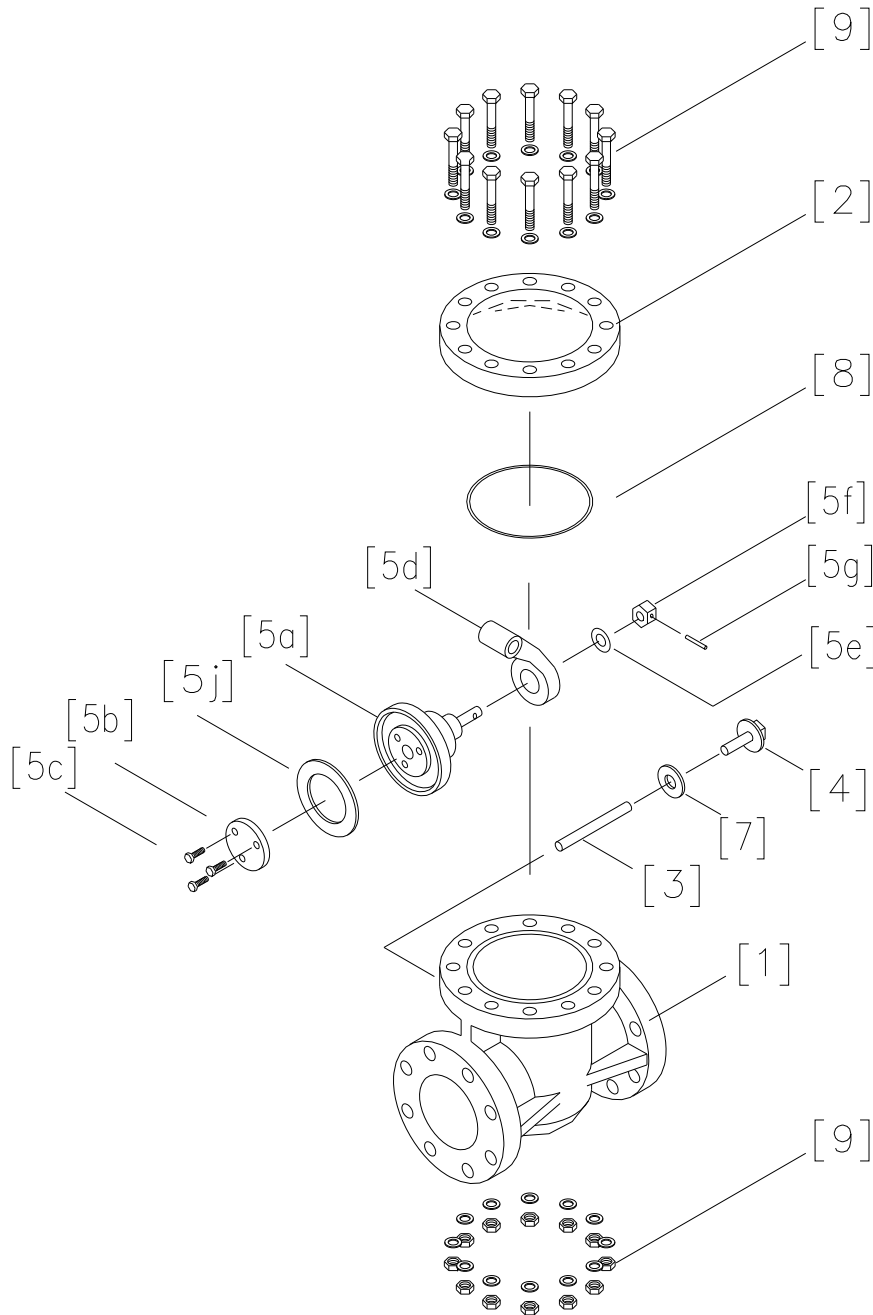

No.	DESCRIPTION	No.	DESCRIPTION	No.	DESCRIPTION
[1]	Body	[5]	[5b]	[5g]	Pin
[2]	Bonnet		[5c]	[5j]	Seat
[3]	Shaft		[5d]	[7]	Gasket (B)
[4]	Plug		[5e]	[8]	O-ring (B)
[5]	[5a]		Disc	[5f]	[9]

*The assembly of Disc ([5a]-[5j]) is not disassembly.

(5) Working pressure vs. temperature

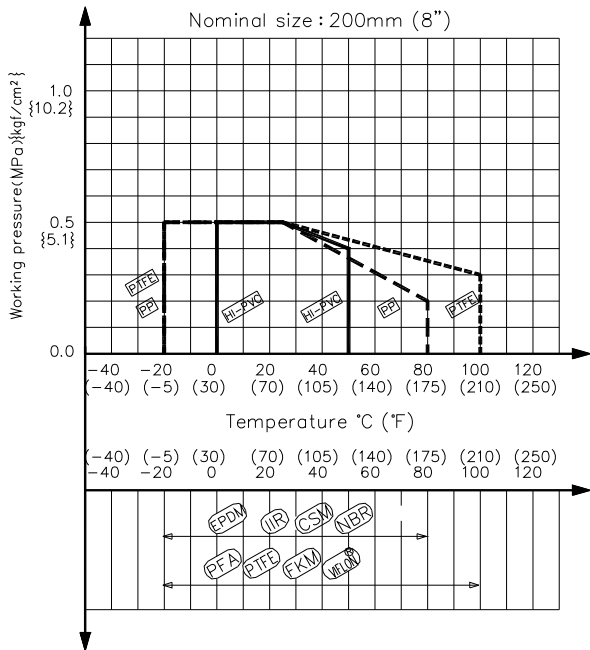
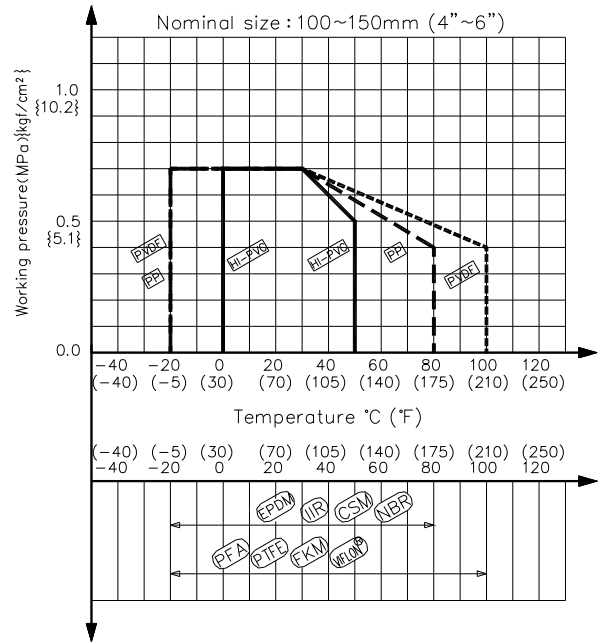
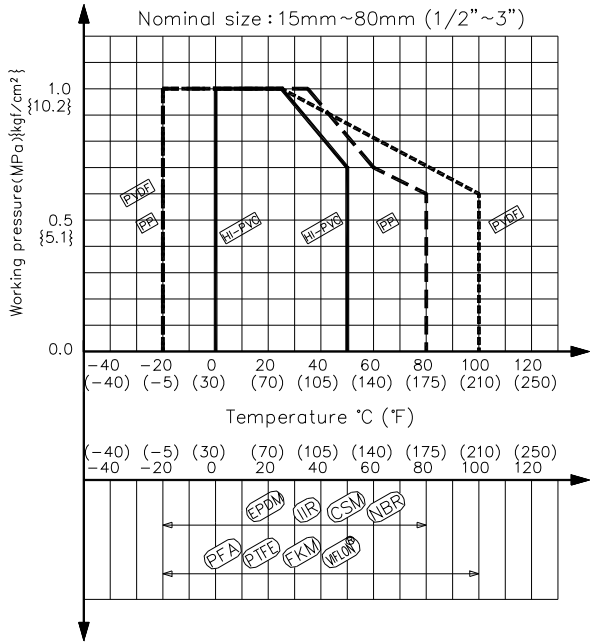

(6) Seal performance (Water Pressure: at R. T.)

Unit: MPa {kgf/cm²}

Nominal Size		Seat	Vertical Piping		Horizontal Piping	
mm	inch		Shut the Disc	Pass the Water	Shut the Disc	Pass the Water
15	1/2	EPDM, others	0.02 {0.2}	0.01 {0.1}	0.02 {0.2}	0.01 {0.1}
		PTFE	0.03 {0.3}	0.01 {0.1}	0.03 {0.3}	0.01 {0.1}
20	3/4	EPDM, others	0.02 {0.2}	0.01 {0.1}	0.02 {0.2}	0.01 {0.1}
		PTFE	0.035 {0.35}	0.01 {0.1}	0.035 {0.35}	0.01 {0.1}
25	1	EPDM, others	0.03 {0.3}	0.01 {0.1}	0.035 {0.35}	0.01 {0.1}
		PTFE	0.05 {0.5}	0.01 {0.1}	0.06 {0.6}	0.01 {0.1}
40	1 1/2	EPDM, others	0.03 {0.3}	0.01 {0.1}	0.035 {0.35}	0.01 {0.1}
		PTFE	0.05 {0.5}	0.01 {0.1}	0.06 {0.6}	0.01 {0.1}
50	2	EPDM, others	0.03 {0.3}	0.01 {0.1}	0.035 {0.35}	0.01 {0.1}
		PTFE	0.05 {0.5}	0.01 {0.1}	0.06 {0.6}	0.01 {0.1}
65	2 1/2	EPDM, others	0.03 {0.3}	0.01 {0.1}	0.035 {0.35}	0.01 {0.1}
		PTFE	0.05 {0.5}	0.01 {0.1}	0.06 {0.6}	0.01 {0.1}
80	3	EPDM, others	0.035 {0.35}	0.01 {0.1}	0.04 {0.4}	0.01 {0.1}
		PTFE	0.055 {0.55}	0.01 {0.1}	0.06 {0.6}	0.01 {0.1}
100	4	EPDM, others	0.035 {0.35}	0.01 {0.1}	0.04 {0.4}	0.01 {0.1}
		PTFE	0.06 {0.6}	0.01 {0.1}	0.065 {0.65}	0.01 {0.1}
125	5	EPDM, others	0.035 {0.35}	0.01 {0.1}	0.04 {0.4}	0.01 {0.1}
		PTFE	0.06 {0.6}	0.01 {0.1}	0.065 {0.65}	0.01 {0.1}
150	6	EPDM, others	0.04 {0.4}	0.015 {0.15}	0.045 {0.45}	0.01 {0.1}
		PTFE	0.065 {0.65}	0.015 {0.15}	0.07 {0.7}	0.01 {0.1}
200	8	EPDM, others	0.04 {0.4}	0.02 {0.2}	0.045 {0.45}	0.015 {0.15}
		PTFE	0.07 {0.7}	0.02 {0.2}	0.07 {0.7}	0.015 {0.15}

*Data mentioned in the table above is reference only.

(7) Installation procedure

Warning

- ⚠️ - When suspending and supporting a valve, take care and do not stand under a suspended valve.
- ⚠️ - Be sure to conduct a safety check on all hand and power tools to be used before beginning work.
- ⚠️ - Wear protective gloves and safety goggles as fluid remain in the valve even if the pipeline is empty. (You may be injured.)

Caution

- ⚠️ - When installing a pipe support by means of a U-band or something similar, take care not to over-tighten. (Excessive force may damage the pipe.)
- ⚠️ - When installing pipes and valves, ensure that they are not subjected to tension, compression, bending, impact, or other excessive stress.
- The valve is applicable to both types: vertical and horizontal piping. In the case of vertical piping, use the valve in applications where the fluid travels upwards.
- Install the piping while matching the arrow on the valve body with the flow direction of the fluid.

Horizontal Piping Vertical Piping

← Dilection of Flow

Caution  - Use flat faced flanges for connection to AV Valves.

- Ensure that the mating flanges are of the same standards.
- Be sure to use sealing gaskets (AV Gasket), bolts, nuts, and washers and tighten them to specified torques.
(When a non-AV gasket is used, a different tightening torque specification should be followed.)

Necessary items

- Torque wrench
- AV gasket
- Spanner wrench
- Bolt, Nut, Washer (For many flanges specification)

Procedure

- 1) Set the AV gasket between the flanges.
- 2) Insert washers and bolts from the pipe side, insert washers and nuts from the valve side, and temporarily tighten them by hand.

Caution  - The parallelism and axial misalignment of the flange surface should be under the values shown in the following table to prevent damage the valve.
(A failure to observe them can cause destruction due to stress application to the pipe)

Unit : mm (inch)

Nom. Size	Axial misalignment	Parallelism (a-b)
15 - 32mm (1/2" - 1 1/4")	1.0 (0.04)	0.5 (0.02)
40 - 80mm (1 1/2" - 3")	1.0 (0.04)	0.8 (0.03)
100 - 150mm (4" - 6")	1.0 (0.04)	1.0 (0.04)
200mm (8")	1.5 (0.06)	1.0 (0.04)

- 3) Using a torque wrench, tighten the bolts and nuts gradually to the specified torque in a diagonal manner.
(Refer to fig.1.)



Caution   - Tighten the bolts and nuts gradually with a torque wrench to the specified torque level in a diagonal manner.

Fig. 1

Recommended torque value

Unit: N·m [kgf·cm] [lb·inch]

Nom. Size	15 - 20mm (1/2" - 3/4")	25 - 40mm (1" - 1 1/2")	50, 65mm (2", 2 1/2")	80, 100mm (3", 4")	125, 150mm (5", 6")	200mm (8")
Rubber	8.0 {82} [71]	20.0 {204} [177]	22.5 {204} [199]	30.0 {306} [265]	40.0 {408} [355]	55.0 {561} [488]
PTFE·PVDF coated	17.5 {179} [155]	20.0 {204} [177]	22.5 {204} [199]	30.0 {306} [265]	40.0 {408} [355]	55.0 {561} [488]

(8) Disassembling method for replacing parts



Warning

- - Be sure to conduct a safety check on all hand and power tools to be used before beginning work.
- - Wear protective gloves and safety goggles as fluid remain in the valve even if the pipeline is empty.
(You may be injured.)
- - Do not change or replace valve parts under line pressure.
- - Be sure to use sealing gaskets (AV Gasket), bolts, nuts, and washers and tighten them to specified torque.
(When a non-AV gasket is used, a different tightening torque specification should be followed.)

Necessary items

- Torque wrench
- Spanner wrench
- Protective gloves
- Safety goggles
- Bolt (For a shaft Disassembly)

<Disassembly>

- 1) Drain fluid completely from the pipe line.
- 2) Loosen the connecting bolts and nuts, and remove the valve from pipeline, if required.
- 3) <In case of 15, 20mm (1/2", 3/4")>
Loosen the bonnet [2] and remove it from the body [1].
<In case of 25-200mm (1" - 8")>
Loosen the bolts and nuts [9] and remove the bonnet [2].
- 4) Loosen the plug [4] and remove it. Thrust the bolt to the threaded hole of shaft [3] and pull out the shaft from the body.

Threaded Hole Size of the Bolt

Nom. Size	15 - 40mm (1/2" - 1 1/2")	50mm (2")	65, 80mm (2 1/2", 3")	100 - 200mm (4" - 8")
Required Bolt Size (Threaded Size)	M4	M5	M6	M8

- 5) Check the worn of all parts. If the part is worn, replace it.

<Assembly>

<Nominal size: 15mm, 20mm (1/2", 3/4")>

- 1) The produce of assembly is the almost reverse of its disassembly.
- 2) Only seat can't be replaced. When the seat has necessity to be replaced, replace the assembly part of seat.
- 3) After completed the assembly, make sure that there is no leakage under the water pressure test.

<Nominal size: 25-200mm (1" - 8")>

- 1) The produce of assembly is the almost reverse of its disassembly.
- 2) Only seat can't be replaced. When the seat has necessity to be replaced, replace the assembly part of seat.
- 3) When the bonnet [2] is replaced, make sure that the arm stopper direction of the bonnet.
- 4) Tighten the bolt•nut [9] diagonally and equally torque to fix the body [1] and bonnet [2].



Bonnet tightening torque value

Unit : N·m {kgf·cm} [lb·inch]

Nom. Size	Torque		Nom. Size	Torque	
	Rubber O-ring	PFA O-ring		Rubber O-ring	PFA O-ring
15mm (1/2")	30.0 {306} [266]	35.0 {357} [310]	65mm (2 1/2")	10.0 {102} [89]	20.0 {204} [177]
20mm (3/4")	30.0 {306} [266]	35.0 {357} [310]	80mm (3")	15.0 {153} [133]	25.0 {255} [221]
25mm (1")	6.0 {61} [53]	10.0 {102} [89]	100mm (4")	20.0 {204} [177]	35.0 {357} [310]
32mm (1 1/4")	8.0 {82} [71]	15.0 {153} [133]	125mm (5")	20.0 {204} [177]	40.0 {408} [354]
40mm (1 1/2")	8.0 {82} [71]	15.0 {153} [133]	150mm (6")	25.0 {225} [221]	40.0 {408} [354]
50mm (2")	10.0 {102} [89]	20.0 {204} [177]	200mm (8")	25.0 {225} [221]	40.0 {408} [354]

- 5) After completed the assembly, make sure that there is no leakage under the water pressure test.

(9) Inspection items

  - Perform periodic maintenance. (Leakage may develop due to temperature changes or over periods of prolonged storage, rest or operation.)



○ Inspect the follow items ;

(1)	Check for any flaw, crack, or deformation on the outside.
(2)	Check whether fluid leaks to the outside.
(3)	Check whether tightness of bolt nut.

(10) Troubleshooting

Problem	Cause	Treatment
The Fluid is leaking past the fully closed position.	The back pressure is low.	Check for the back pressure.
	Seat is worn.	Replacement.
	Solid particles have lodged in the valve.	Clear the solid particles from the valve.
Fluid leaks from the valve	O-ring is worn.	Replacement.
	Packing is worn.	Replacement.
	Looseness of bolts • nut.	Retighten.

(11) Handling of residual and waste materials

  - Make sure to consult a waste treatment dealer for recommendations on the proper disposal of plastic valves. (Poisonous gas is generated when the valve is burned improperly.)

Swing check valve**ASAHI YUKIZAI CORPORATION****Distributor**<http://www.asahi-yukizai.co.jp/en/>